

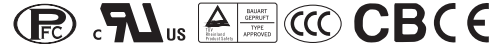

■ Features :

- Universal AC input / full range
- Built-in active PFC function, PF>0.93
- Protections: Short circuit / Overload / Over voltage / Over temperature
- Built-in cooling fan speed control
- Built-in constant current limiting circuit
- Built-in fan speed control
- Remote ON-OFF control(Optional)
- LED indicator for power on
- 100% full load burn-in test
- Fixed switching frequency at PFC:67KHz PWM:134KHz
- 3 years warranty



SPECIFICATION

MODEL	SP-200-3.3	SP-200-5	SP-200-7.5	SP-200-12	SP-200-13.5	SP-200-15	SP-200-24	SP-200-27	SP-200-48		
OUTPUT	DC VOLTAGE	3.3V	5V	7.5V	12V	13.5V	15V	24V	27V	48V	
	RATED CURRENT	40A	40A	26.7A	16.7A	14.9A	13.4A	8.4A	7.5A	4.2A	
	CURRENT RANGE	0 ~ 40A	0 ~ 40A	0 ~ 26.7A	0 ~ 16.7A	0 ~ 14.9A	0 ~ 13.4A	0 ~ 8.4A	0 ~ 7.5A	0 ~ 4.2A	
	RATED POWER	132W	200W	200.2W	200.4W	201.1W	201W	201.6W	202.5W	201.6W	
	RIPPLE & NOISE (max.) Note.2	100mVp-p	100mVp-p	100mVp-p	100mVp-p	100mVp-p	100mVp-p	150mVp-p	150mVp-p	250mVp-p	
	VOLTAGE ADJ. RANGE	3.14 ~ 3.63V	4.75 ~ 5.5V	7.13 ~ 8.25V	11.4 ~ 13.2V	12.8 ~ 14.9V	14.3 ~ 16.5V	22.8 ~ 26.4V	25.7 ~ 29.7V	45.6 ~ 52.8V	
	VOLTAGE TOLERANCE Note.3	±2.0%	±2.0%	±2.0%	±2.0%	±2.0%	±2.0%	±1.0%	±1.0%	±1.0%	
	LINE REGULATION	±0.5%	±0.5%	±0.5%	±0.5%	±0.5%	±0.5%	±0.5%	±0.5%	±0.5%	
	LOAD REGULATION	±1.0%	±1.0%	±1.0%	±0.5%	±0.5%	±0.5%	±0.5%	±0.5%	±0.5%	
	SETUP, RISE TIME	600ms, 40ms at full load									
HOLD UP TIME (Typ.)	20ms at full load										
INPUT	VOLTAGE RANGE	85 ~ 264VAC		120 ~ 370VDC							
	FREQUENCY RANGE	47 ~ 63Hz									
	POWER FACTOR (Typ.)	PF>0.93/230VAC		PF>0.97/115VAC at full load							
	EFFICIENCY (Typ.)	69%	76%	78.5%	84%	84%	84%	85%	85%	85%	
	AC CURRENT (Typ.)	3.5A/115VAC		1.7A/230VAC							
	INRUSH CURRENT (Typ.)	COLD START 50A/230VAC									
	LEAKAGE CURRENT	<2mA / 240VAC									
PROTECTION	OVERLOAD	105 ~ 150% rated output power Protection type : Constant current limiting, recovers automatically after fault condition is removed									
	OVER VOLTAGE	3.63 ~ 4.46V	5.5 ~ 6.75V	8.25 ~ 10.13V	13.2 ~ 16.2V	14.85 ~ 18.2V	16.5 ~ 20.25V	26.4 ~ 32.4V	29.7 ~ 36.45V	52.8 ~ 64.8V	
	OVER TEMPERATURE	80°C ±5°C (TSW1 : detect on heatsink of power transistor) Protection type : Shut down o/p voltage, recovers automatically after temperature goes down									
FUNCTION	REMOTE CONTROL(OPTION)	CN1:4 ~ 10VDC POWER ON, <0 ~ 0.8VDC POWER OFF									
ENVIRONMENT	WORKING TEMP.	-10 ~ +60°C (Refer to output load derating curve)									
	WORKING HUMIDITY	20 ~ 90% RH non-condensing									
	STORAGE TEMP., HUMIDITY	-20 ~ +85°C, 10 ~ 95% RH									
	TEMP. COEFFICIENT	±0.05%/°C (0 ~ 50°C)									
	VIBRATION	10 ~ 500Hz, 2G 10min./1cycle, 60min. each along X, Y, Z axes									
SAFETY & EMC (Note 4)	SAFETY STANDARDS	UL60950-1, TUV EN60950-1, CCC GB4943 approved									
	WITHSTAND VOLTAGE	I/P-O/P:3KVAC			I/P-FG:2KVAC			O/P-FG:0.5KVAC			
	ISOLATION RESISTANCE	I/P-O/P, I/P-FG, O/P-FG:100M Ohms / 500VDC / 25°C/70% RH									
	EMC EMISSION	Compliance to EN55022 (CISPR22) Class B, EN61000-3-2, -3									
	EMC IMMUNITY	Compliance to EN61000-4-2,3,4,5,6,8,11; ENV50204, EN55024, light industry level, criteria A									
OTHERS	MTBF	183.8K hrs min. MIL-HDBK-217F (25°C)									
	DIMENSION	199*99*50mm (L*W*H)									
	PACKING	0.85Kg; 20pcs/17.9Kg/1.28CUFT									
NOTE	<p>1. All parameters NOT specially mentioned are measured at 230VAC input, rated load and 25°C of ambient temperature.</p> <p>2. Ripple &amp; noise are measured at 20MHz of bandwidth by using a 12" twisted pair-wire terminated with a 0.1uf &amp; 47uf parallel capacitor.</p> <p>3. Tolerance : includes set up tolerance, line regulation and load regulation.</p> <p>4. The power supply is considered a component which will be installed into a final equipment. The final equipment must be re-confirmed that it still meets EMC directives. For guidance on how to perform these EMC tests, please refer to "EMI testing of component power supplies." (as available on <a href="http://www.meanwell.com">http://www.meanwell.com</a>)</p>										

**Mechanical Specification**

Case No. 916B Unit:mm

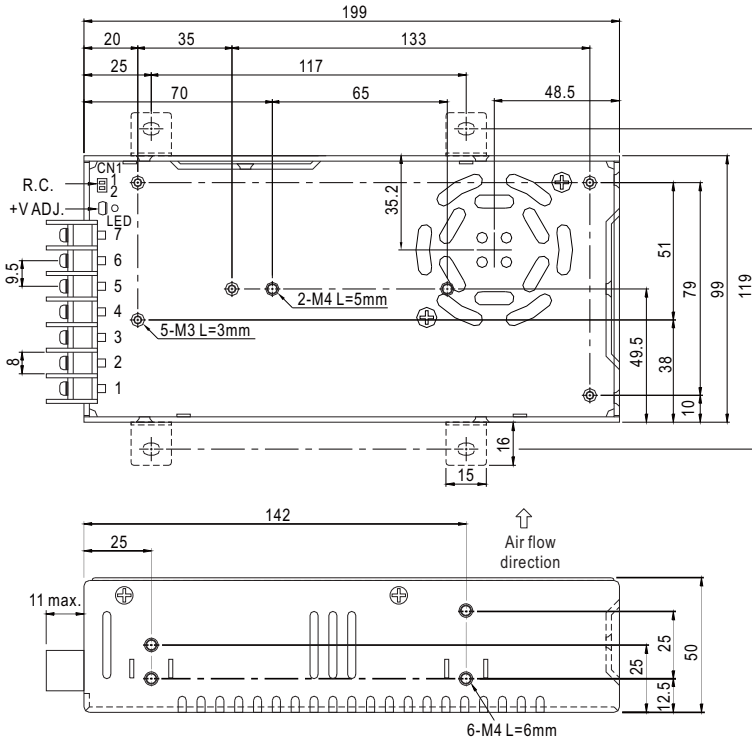

**Terminal Pin No. Assignment**

Pin No.	Assignment	Pin No.	Assignment
1	AC/L	4,5	DC OUTPUT -V
2	AC/N	6,7	DC OUTPUT +V
3	FG $\perp$		

Remote ON/OFF(CN1): JST S2B-XH or equivalent(optional)

Pin No.	Assignment	Mating Housing	Terminal
1	RC+	JST XHP or equivalent	JST SXH-001T-P0.6 or equivalent
2	RC-		

**Block Diagram**

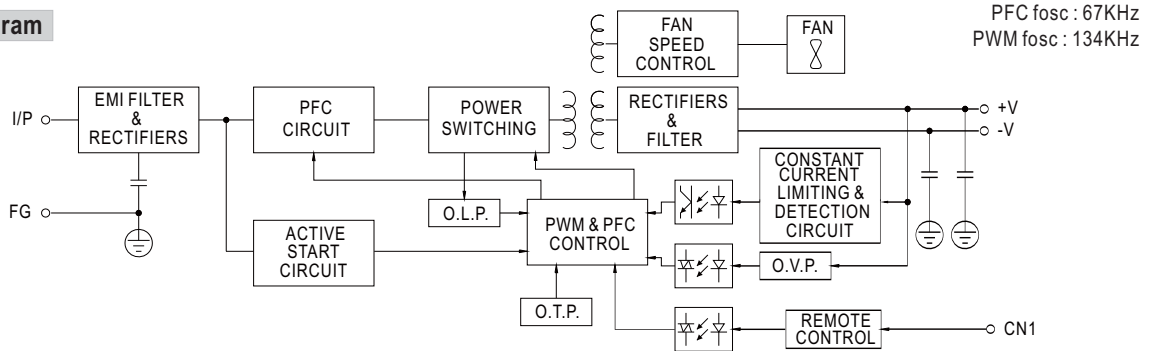

**Derating Curve**

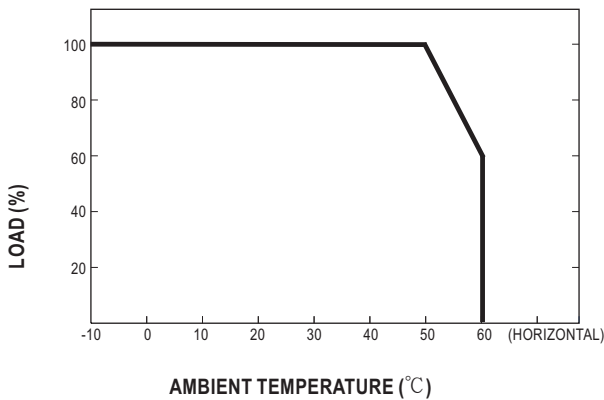

**Output Derating VS Input Voltage**

